

1980 KZ550-A1 PARTS DIAGRAM

CLUTCH ('80-'81 A1/A2)

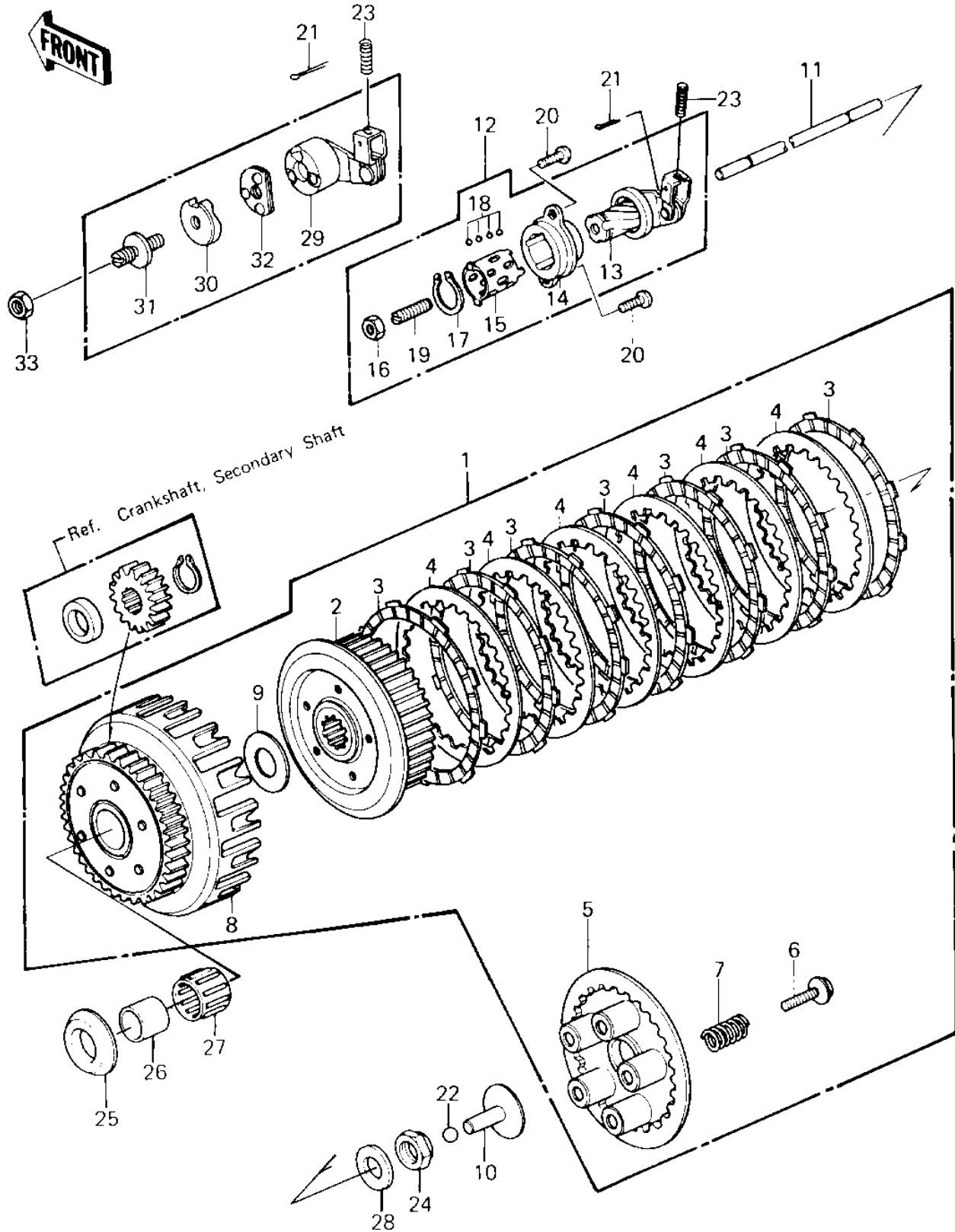

1980 KZ550-A1 PARTS LIST

CLUTCH ('80-'81 A1/A2)

ITEM NAME	PART NUMBER	QUANTITY
CLUTCH-ASSY (Ref # 1)	13081-1044	1
HUB-CLUTCH (Ref # 2)	13087-1052	1
PLATE,CLUTCH FRICTION (Ref # 3)	13088-040	2
PLATE,CLUTCH STEEL (Ref # 4)	13089-026	6
PLATE,CLUTCH SPRING (Ref # 5)	13187-008	1
BOLT,CLUTCH SPR FITT (Ref # 6)	92001-1066	5
SPRING,CLUTCH (Ref # 7)	92081-139	5
HOUSING,CLUTCH,65T (Ref # 8)	13095-1030	1
WASHER TH 25.5X47X2.5 (Ref # 9)	92026-022	1
PUSHER,CLTCH SPRG PLT (Ref # 10)	13116-029	1
ROD,CLUTCH PUSH (Ref # 11)	13116-1007	1
RELEASE ASSY,CLUTCH (Ref # 12)	13231-020	1
INNER,CLUTCH RELEASE (Ref # 13)	13102-027	1
OUTER,CLUTCH RELEASE (Ref # 14)	13118-011	1
RETAINER (Ref # 15)	13197-004	1
NUT 8MM (Ref # 16)	318B0800	1
CIRCLIP 15MM (Ref # 17)	480J1500	1
BALL,STEEL,1/8" (Ref # 18)	600A0400	11
SCREW,SLOTTED,8X25 (Ref # 19)	92014-014	1
SCREW PAN HEAD 6X16 (Ref # 20)	220B0616	2
PIN COTTER 1.6X15 (Ref # 21)	550D1615	1
BALL STEEL 3/8" (Ref # 22)	600A1200	1
SPRING-CLUTCH RELEASE (Ref # 23)	92081-069	1
NUT,20MM (Ref # 24)	92015-1555	1
SPACER,THRUST,T=5.5MM (Ref # 25)	92026-116	1
BUSHING,CLUTCH (Ref # 26)	92028-178	1
BEARING,KTV323723 (Ref # 27)	92046-028	1
WASHER (Ref # 28)	92125-002	1
RELEASE,CLUTCH (Ref # 29)	13102-1008	1

1980 KZ550-A1 PARTS LIST

CLUTCH ('80-'81 A1/A2)

ITEM NAME	PART NUMBER	QUANTITY
CAM,RELEASE,CLUTCH (Ref # 30)	13119-1003	1
SCREW,SLOTTED,8M/M (Ref # 31)	92009-1009	1
BEARING,BALL,CLUTCH (Ref # 32)	92045-1001	1
NUT 8MM (Ref # 33)	318B0800	1