

1980 KZ550-A1 PARTS DIAGRAM

ENGINE COVERS ('80-'81 A1/A2)

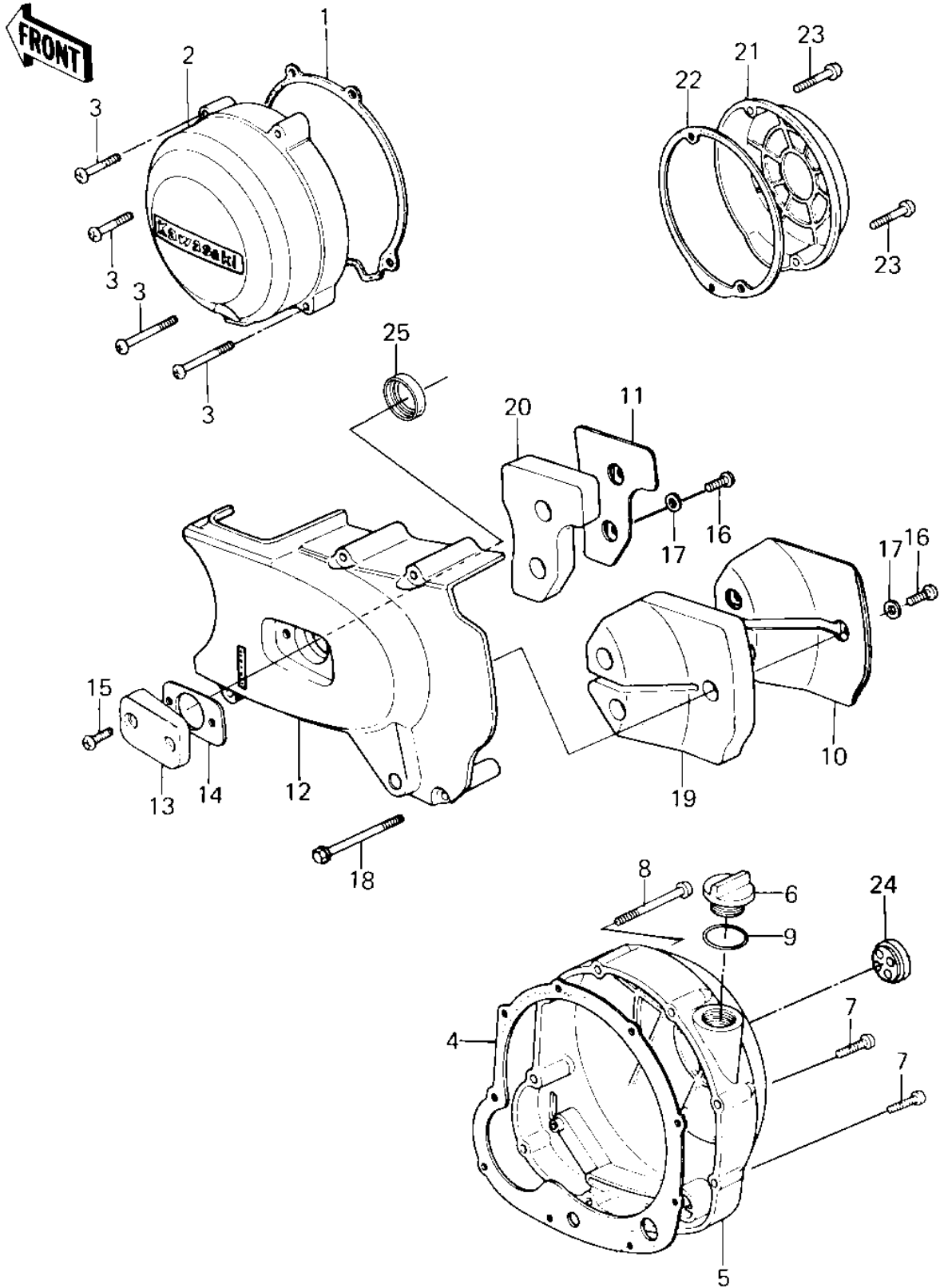

1980 KZ550-A1 PARTS LIST

ENGINE COVERS ('80-'81 A1/A2)

ITEM NAME	PART NUMBER	QUANTITY
GASKET,GENERATOR COVE (Ref # 1)	11060-1055	1
COVER,GENERATOR,BUFF (Ref # 2)	14031-1014	1
SCREW PAN HEAD 6X40 (Ref # 3)	220B0640	4
GASKET,CLUTCH COVER (Ref # 4)	11060-1054	1
COVER,CLUTCH,BUFF (Ref # 5)	14032-5004	1
PLUG,OIL FILLER (Ref # 6)	16115-013	1
SCREW PAN HEAD 6X30 (Ref # 7)	220B0630	7
SCREW PAN HEAD 6X60 (Ref # 8)	220B0660	2
"O" RING,31MM (Ref # 9)	92055-049	1
COVER,SOUND ARRESTER (Ref # 10)	14025-1115	1
COVER,SOUND ARRESTER (Ref # 11)	14025-1116	1
COVER,CHAIN (Ref # 12)	14026-1015	1
COVER,CHAIN (Ref # 12)	14026-1047	1
COVER,CLUTCH ADJUSTNG (Ref # 13)	14028-006-80	1
GASKET,CLUTCH ADJ CAP (Ref # 14)	14049-004	1
SCREW PAN HEAD 6X18 (Ref # 15)	220B0618	2
SCREW PAN HEAD 6X12 (Ref # 16)	220B0612	5
WASHER PLAIN 6MM (Ref # 17)	410B0600	5
BOLT-FLANGED,6X70 (Ref # 18)	130G0670	4
DAMPER,CHAIN COVER RR (Ref # 19)	92075-1158	1
DAMPER,CHAIN COVER FR (Ref # 20)	92075-1159	1
CAP,CONTACT BREAKER (Ref # 21)	11012-1098	1
GASKET,PULSING COIL C (Ref # 22)	11060-1053	1
SCREW PAN HEAD 6X30 (Ref # 23)	220B0630	2
GAUGE,OIL LEVEL (Ref # 24)	52005-1009	1
OIL SEAL,CLUTCH RELES (Ref # 25)	92049-1003	1